

Freestanding Designer Fireplace

ecosmart⁺
Fire

T-Lite Series



ecosmartfire.com

T-Lite Series Design features



1. Surround Colours

Available in two colours, brushed stainless steel or black.

Available in 2 Sizes

T-Lite 8 stands 539mm [21.2in] tall, 428mm [16.9in] wide. The smaller T-Lite 3 stands 456mm [18in] tall, 340mm [13.4in] wide.

Enjoy Indoors & Outdoors

The T-Lite Series come with an Indoor Safety Tray, so you can enjoy your fire indoors. Simply remove the Tray to use outdoors.

No Flue, No Chimney, No Electricity Connection

Our freestanding fireplaces offer an easy and immediate, environmentally friendly solution to adding warmth and ambiance to any location.

2. Glass Screen Included

The glass screens stabilise the flame in windy conditions and provide an added layer of safety, peace of mind and comfort.

Quick and Easy Installation

With no installation or building works required, simply unpack, put in position, and off you go.

Portable Fireplace

Fully portable, you can move the fireplace between rooms and outdoor spaces, or store away when not needed.

Ground Fixing Brackets

Models come with fixing brackets for permanently locating into a fixed position.

3. Burner Colours

Available with a stainless steel or black burner.

Environmentally-Friendly

Bioethanol fireplaces use an environmentally-friendly, renewable energy source that burns clean and delivers warming heat. You and your guests will enjoy the ambiance and tranquility of a real fire, without the hassles of burning real wood - no more embers, ash, and soot to clean up.

Global Compliance

These models comply with existing standards in the USA, Europe, UK and Australia. O-TL listed to UL 1370, EN 16647 BSI Certified and ACCC Safety Mandate compliant.

Included Accessories



Jerry Can with Safety Spout & e-NRG bottle adaptor



Lighting Rod & Lighter



Jerry Can Spout Extension

Optional Accessories



Outdoor Covers

Disclaimer: All product specifications and data are subject to change without notice and believed to be correct at the time of publication. MAD Design Group (MDG), its affiliates, agents, and employees, and all persons acting on its or their behalf (collectively, "MAD Design Group"), disclaim any and all liability for any errors, inaccuracies or incompleteness contained herein or in any other disclosure relating to any product. MDG disclaims any and all liability arising out of the use or application of any product described herein or of any information provided herein to the maximum extent permitted by law. The product specifications do not expand or otherwise modify MDG's terms and conditions of purchase, including but not limited to the warranty expressed therein, which apply to these products. No license, express or implied, by estoppel or otherwise, to any intellectual property rights is granted by this document or by any conduct of MDG. Customers using or selling MDG products not expressly indicated for use in such applications do so entirely at their own risk and agree to fully indemnify MDG for any damages arising or resulting from such use or sale. Please contact authorised personnel from MDG to obtain written terms and conditions regarding products designed for such applications. Images are indicative only.

T-Lite 8 Specifications

Cylindrical shaped, inspired by ‘tealight candles’, T-Lite 8 makes a dramatic statement in any outdoor or indoor setting for trans-seasonal enjoyment.

Burner Ventilation and Efficiency*

Dimensions L x W x H mm/in	Compatible Burner	Fuel Capacity	Heats on Average (Indoors)	Thermal Output Net (MAX per burner)	Approx. Burn Time	Minimum Room Size
428 x 428 x 539 16.9 x 16.9 x 21.2	AB8	8 L [2.1 Gals]	Over 60 m ² [645 ft ²]	21.56 MJ/h 20,433 BTU/h, 5.99 kW	7 - 9 hours	116 m ³ [4,096 ft ³]
			Over 30 m ² [322.9 ft ²]	13.9 MJ/h 12,860 BTU/h, 3.77 kW	9 - 11 hours	

*With AB8 Efficiency Ring** (EN Compliant)*

Application	Indoor & Outdoor
Surround Colours	 Stainless Steel ESF.D.TLT.8.SS Black ESF.D.TLT.8.BL
Burner Colours	 Stainless Steel Black
Materials	Grade 304 Brushed Stainless Steel surround with optional Black Powder-Coating, Grade 304 Stainless Steel Burner with optional Black Ceramic Coating, Borosilicate Glass Fire Screen
Approx. Weight	18.2kg [40.1lbs] Weight includes burner.
Fuel Type	e-NRG Bioethanol / e-NRG.com

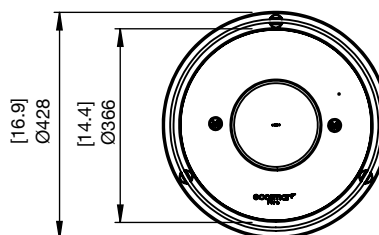
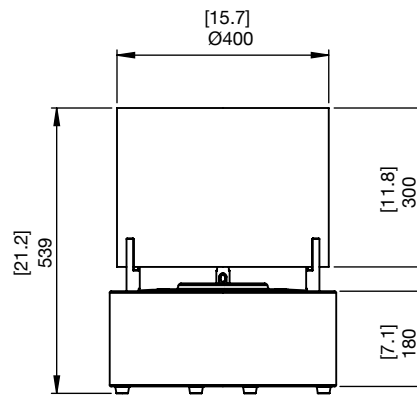

*These values are indicative only and may vary depending on the model purchased, installation, and the seasonal resource used to manufacture e-NRG.
This model comes with fixing brackets for permanently locating into a fixed position.
This model complies with existing standards in the USA, Europe, UK and Australia. O-TL listed to UL 1370, EN 16647 BSI Certified and ACCC Safety Mandate compliant.







FOR MORE INFORMATION PLEASE REFERENCE THE CLEARANCE & INSTALLATION MANUAL



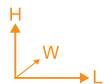

Disclaimer: All product specifications and data are subject to change without notice and believed to be correct at the time of publication. MAD Design Group (MDG), its affiliates, agents, and employees, and all persons acting on its or their behalf (collectively, "MAD Design Group"), disclaim any and all liability for any errors, inaccuracies or incompleteness contained herein or in any other disclosure relating to any product. MDG disclaims any and all liability arising out of the use or application of any product described herein or of any information provided herein to the maximum extent permitted by law. The product specifications do not expand or otherwise modify MDG's terms and conditions of purchase, including but not limited to the warranty expressed therein, which apply to these products. No license, express or implied, by estoppel or otherwise, to any intellectual property rights is granted by this document or by any conduct of MDG. Customers using or selling MDG products not expressly indicated for use in such applications do so entirely at their own risk and agree to fully indemnify MDG for any damages arising or resulting from such use or sale. Please contact authorised personnel from MDG to obtain written terms and conditions regarding products designed for such applications. Images are indicative only.

T-Lite 3 Specifications

The hypnotic glow created by the tealight candle-inspired T-Lite 3 will bring warmth and atmosphere to any outdoor or indoor setting.

Burner Ventilation and Efficiency*

 Dimensions L x W x H mm/in	 Compatible Burner	 Fuel Capacity	 Heats on Average (Indoors)	 Thermal Output Net (MAX)	 Approx. Burn Time	 Minimum Room Size
340 x 340 x 459 13.4 x 13.4 x 18.1	AB3	2.5 L [0.7 Gals]	Over 20 m ² [215 ft ²]	6.14 MJ/h 5,800 BTU/h 1.7 kW	8 - 11 hours	40 m ³ [1,413 ft ³]

Application	Indoor & Outdoor
Surround Colours	 Stainless Steel ESF.D.TLT.3.SS  Black ESF.D.TLT.3.BL
Burner Colours	 Stainless Steel  Black
Materials	Grade 304 Brushed Stainless Steel surround with optional Black Powder-Coating, Grade 304 Stainless Steel Burner with optional Black Ceramic Coating, Borosilicate Glass Fire Screen
Approx. Weight	12.2kg [26.8lbs] Weight includes burner.
Fuel Type	e-NRG Bioethanol / e-NRG.com

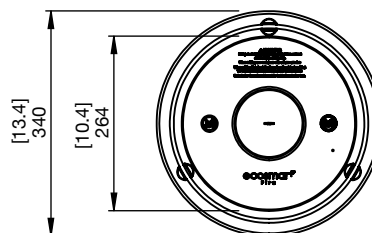
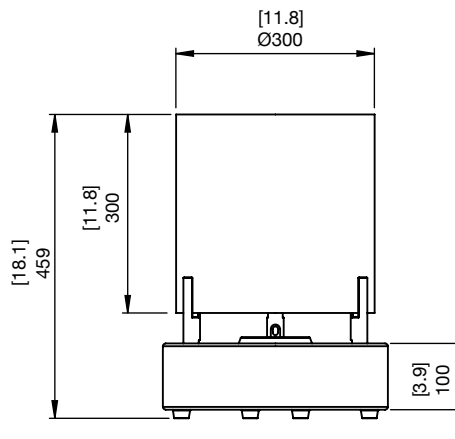

*These values are indicative only and may vary depending on the model purchased, installation, and the seasonal resource used to manufacture e-NRG.
This model comes with fixing brackets for permanently locating into a fixed position.
This model complies with existing standards in the USA, Europe, UK and Australia. O-TL listed to UL 1370, EN 16647 BSI Certified and ACCC Safety Mandate compliant.

FOR MORE INFORMATION PLEASE REFERENCE THE CLEARANCE & INSTALLATION MANUAL

Disclaimer: All product specifications and data are subject to change without notice and believed to be correct at the time of publication. MAD Design Group (MDG), its affiliates, agents, and employees, and all persons acting on its or their behalf (collectively, "MAD Design Group"), disclaim any and all liability for any errors, inaccuracies or incompleteness contained herein or in any other disclosure relating to any product. MDG disclaims any and all liability arising out of the use or application of any product described herein or of any information provided herein to the maximum extent permitted by law. The product specifications do not expand or otherwise modify MDG's terms and conditions of purchase, including but not limited to the warranty expressed therein, which apply to these products. No license, express or implied, by estoppel or otherwise, to any intellectual property rights is granted by this document or by any conduct of MDG. Customers using or selling MDG products not expressly indicated for use in such applications do so entirely at their own risk and agree to fully indemnify MDG for any damages arising or resulting from such use or sale. Please contact authorised personnel from MDG to obtain written terms and conditions regarding products designed for such applications. Images are indicative only.